



**HAL**  
open science

## Impact of AC vs DC Distribution on System Efficiency in a Nanogrid Office

Olivia Graillet, Frédéric Aicalapa, Denis Genon-Catalot, Pierre-Olivier Lucas  
de Peslouan, Laurent Lemaitre, Jean-Pierre Chabriat

► **To cite this version:**

Olivia Graillet, Frédéric Aicalapa, Denis Genon-Catalot, Pierre-Olivier Lucas de Peslouan, Laurent Lemaitre, et al.. Impact of AC vs DC Distribution on System Efficiency in a Nanogrid Office. 2023 IEEE Region 10 Symposium (TENSYP), Sep 2023, Canberra, Australia. pp.1-5, 10.1109/TEN-SYMP55890.2023.10223664 . hal-04483116

**HAL Id: hal-04483116**

**<https://hal.univ-reunion.fr/hal-04483116>**

Submitted on 29 Feb 2024

**HAL** is a multi-disciplinary open access archive for the deposit and dissemination of scientific research documents, whether they are published or not. The documents may come from teaching and research institutions in France or abroad, or from public or private research centers.

L'archive ouverte pluridisciplinaire **HAL**, est destinée au dépôt et à la diffusion de documents scientifiques de niveau recherche, publiés ou non, émanant des établissements d'enseignement et de recherche français ou étrangers, des laboratoires publics ou privés.

# Impact of AC vs DC distribution on system efficiency in a nanogrid office

Olivia GRILLET  
ENERGY-Lab, EA4079  
University of La Réunion  
Saint-Denis, La Réunion, France  
0000-0002-9787-4403

Frédéric ALICALAPA  
ENERGY-Lab, EA4079  
University of La Réunion  
Saint-Denis, La Réunion, France  
frederic.alicalapa@univ-reunion.fr

Denis GENON-CATALOT  
LCIS, EA3747  
University of Grenoble Alpes  
Valence, France  
denis.genon-catalot@lcis.grenoble-inp.fr

Pierre-Olivier LUCAS DE  
PESLOUAN  
ENERGY-Lab, EA4079  
University of La Réunion  
Saint-Denis, La Réunion, France

Laurent LEMAITRE  
Intégrale Ingenierie  
Saint-Gilles, La Réunion, France  
laurent.lemaitre@integrale.re

Jean-Pierre CHABRIAT  
ENERGY-Lab, EA4079  
University of La Réunion  
Saint-Denis, La Réunion, France  
jean-pierre.chabriat@univ-reunion.fr

**Abstract**—Réunion Island is a French overseas department located in the southwestern part of the Indian Ocean. Due to its geographical location, it needs to develop local sources of energy production, such as solar energy, to achieve energy autonomy. By reducing energy conversion steps, LVDC (Low-Voltage Direct Current) nanogrids can contribute to this objective by reducing the energy consumption of buildings and optimizing electrical installations. This paper proposes a hybrid nanogrid architecture currently deployed in an office building in Réunion island. The hybrid nanogrid includes a PV power plant, a LiFePO<sub>4</sub> battery, a LVDC distribution (48VDC loads such as lighting and fans) and an Alternating Current (AC) distribution for experimentation. To evaluate the overall nanogrid efficiency and optimize its lifetime, a method to measure the global efficiency of the system in AC or DC distribution for an identical final load and section cable is presented. Results have shown a total efficiency gain of 18% in DC compared to AC distribution, for certain conditions described in the paper. Voltage drop and battery capacity during discharge have also been measured to complete the results.

**Keywords**—Hybrid nanogrid, LVDC nanogrid, LFP battery, system efficiency, DC distribution, converter

## I. INTRODUCTION

French LTCEV (Law on Energy Transition for Green Growth) stipulates that the French overseas departments aim to reach energy autonomy by 2030. The French BACS (Building Automation and Control System) decree indicates that from September 2022, tertiary buildings of more than 1000 m<sup>2</sup> must reference their energy consumption data to justify their commitment to compliance with the French tertiary decree [1].

In 2020, the tertiary sector accounted for 41% of the total electricity consumed in Réunion Island, as reported by EDF Réunion (Electricity of France) [2]. Furthermore, electricity produced on the island emits 687 gCO<sub>2</sub>eq per kWh [3]. To reduce the carbon impact of buildings, it is crucial to focus on reducing energy consumption through user behavior and building renovations, along with the adoption of renewable energy sources such as solar power.

The potential of DC (Direct Current) distribution has been studied for several years [4][5] since they present advantages in terms of efficiency, savings energy, from 15 to 30%, and carbon impact: they promise fewer energy conversions, less dimension of equipment and an overall efficiency superiority to an AC (Alternating Current) nanogrid for short distances.

According to [6], a nanogrid is defined as an "energy distribution system, having at least one load and at least one gateway to the outside. The electrical distribution of the nanogrid can be carrying out in direct current, in alternating current or in a hybrid way. It can operate in islanded or grid-connected mode". Several interconnected nanogrids form a microgrid. Generally, they integrate renewable energy sources (PV, wind) and a storage system. Some DC nanogrid have already been deployed for residential application [7][8] but characterizing the efficiency of micro and nanogrids is still a challenge [9] due to the large number of application cases.

This paper presents a hybrid nanogrid architecture integrated into an operative enterprise office. The nanogrid is capable of supplying power to both DC (12, 24, 48 VDC) and AC (230VAC) loads. Before deploying the final equipment, battery discharging tests were performed for this study on the LFP (Lithium Iron Phosphate) battery to quantify the system's efficiency according to different distribution buses. The tests were carried out in 230 VAC or 48 VDC bus for a load operating in 48 VDC, for an identical distance and cable section, and additional converters if needed.

## II. HYBRID NANOGRID OFFICE ARCHITECTURE

### A. Existing office site - AC distribution

The existing office space has an area of 590 m<sup>2</sup> and accommodates about 40 employees daily. Sub-meters are measuring the premise's energy consumption, which allowed us to identify that the equipment operating in DC, such as lighting, EV (Electric Vehicles) and IT appliances represented 42% of the annual energy consumption in 2022, as shown in Table 1:

TABLE 1 : ANNUAL ENERGY CONSUMPTION (KWH) AND REPARTITION ON TOTAL ENERGY CONSUMPTION (%) FOR DC AND AC APPLIANCES IN CURRENT OFFICE IN 2022

DC appliances	EV	Lighting	IT
(kWh)	3583	3461	12471
(%)	8	7	27
AC appliances	Cooling	Fans	Other outlets
(kWh)	20362	445	6003
(%)	44	1	13

These devices each have built-in AC-DC converters to be compatible with the current power grid. These converters have a share in the total energy consumption of each

appliance that we have quantified by instrumenting upstream and downstream of the converters: 17% of IT consumption is for the UPS (Uninterruptible Power Supply), and 13% of lighting consumption is for AC-DC converter. In order to reduce these additional energy consumptions, the nanogrid installation's purpose is to study the efficiency of a DC distribution, starting with lighting and ventilation and, as a case study, two individual offices (localization in Fig 1).

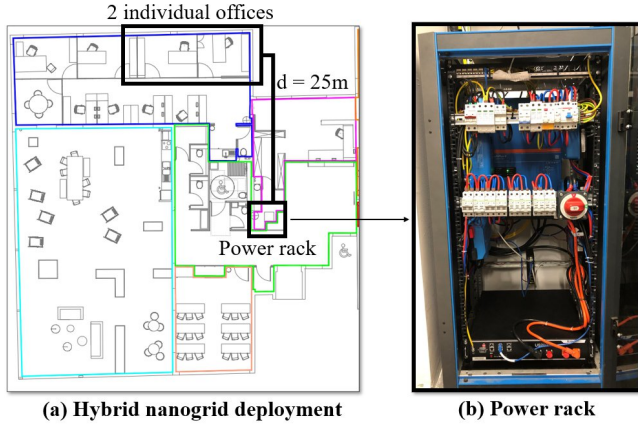

Fig. 1 : (a) Localization of the nanogrid deployment in current office.  
(b) Nanogrid power rack photo

Reunion Island has a subtropical climate divided into two periods: the southern winter and the southern summer. Thanks to installing a solar and meteorological station on the roof, we have noted sunshine between 6 am and 6 pm during winter and between 5:30 am and 7:30 pm on average during summer. For this study, presence sensors have been put in individual offices. In the worst case, the user stays 2 hours left after sunset. These elements on the sunlight conditions and on the user behaviour have conditioned the test elements in the following section.

### B. Hybrid Nanogrid architecture

Hybrid nanogrid architecture is detailed in Fig 2. It is composed of a photovoltaic power plant, a LFP battery, a Power Over Ethernet (PoE) switch, PoE drivers to manage the power of the terminal equipment, which are lighting and ventilation.

The following technological choices have been established:

- 48 VDC distribution: proposed best level choice for short distances. [12]
- Bidirectional inverter: the connection to the grid is not effective as the goal is to study system efficiency in an islanded mode and the AC distribution has been added to evaluate the impact on battery discharge.
- Power Over Ethernet (PoE) as power management and power supply: useful for loads of less than 100W because we use less wiring and adjust precisely power management [10]. As shown in Tab. 1, the high energy consumption for cooling needs to be reduced by optimizing the management of ventilation. DC fans management could be facilitated with PoE driver by facilitating communication between outdoor, and indoor conditions through environmental sensors. By analyzing these thermal conditions, power commands can be sent to the electrical equipment.

- LFP battery storage: The LFP battery used in this study has a nominal voltage of 48VDC, a nominal capacity of 2.4 kWh and 6000 cycle life. This energy storage technology has a longer life and better safety than other batteries but still strong environmental impact [11]. Therefore, studying its discharge behavior can contribute to completing the studies carried out on the issues related to its insertion in micro-grids, such as analyzing state of health and cycling process [13].
- SCADA (Supervisory Control and Data Acquisition): Influxdb database and an internally developed application are using as SCADA system, both based on open-source technologies.

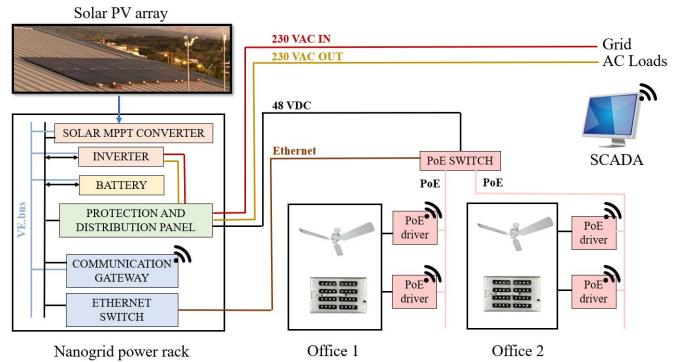

Fig. 2 : Hybrid nanogrid architecture block diagram

In order to increase the lifetime of the nanogrid and primarily the battery, the tests presented in the following section aim to propose efficiency criteria to evaluate under which conditions the system is optimal. We will focus particularly by regarding its overall efficiency and the quality of the battery discharge.

### III. TESTS PLANNED FOR SYSTEM EFFICIENCY ANALYSIS

At the moment, the solar panels and the hybrid power rack are installed in the company. Before installing the terminal DC appliances (LEDs and fans), the following tests were performed with a programmable DC electronic load in order to simulate the behaviour of the DC appliances according to different distribution buses:

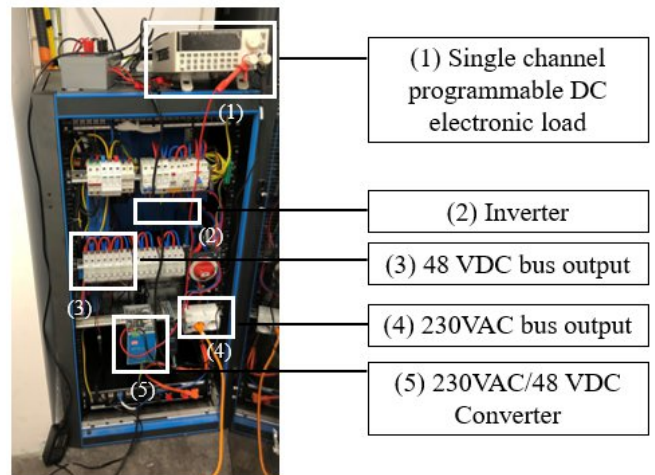

Fig. 3 : Testbed for battery discharge setup

For this study, two tests have been identified for a comparison between AC or DC distribution.

### A. Test 1 : Battery discharge in DC/AC/DC distribution

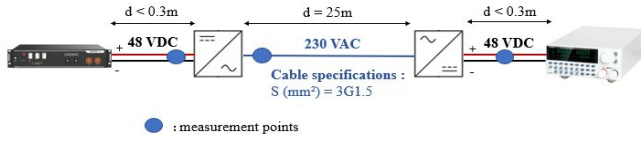

Fig. 4 : Test 1 DC/AC/DC distribution - block diagram

This first test corresponds to a conventional installation if we integrate solar energy, a battery and an inverter to have 230VAC distribution and we integrate a 230VAC to 48VDC converter for DC loads. As the voltage drop is negligible in AC, the theoretical efficiency of the system is identified by the efficiency of the converters, given by the technical specifications of the manufacturers. The diagram of the test bench is shown above (Fig 4) : the blue points correspond to measurement points that have been made. The power delivered by the battery and the input and output power of the inverter is communicated via the communication gateway (Fig. 2). The DC load is also communicating current, voltage and power data.

### B. Test 2 : Battery discharge in DC distribution

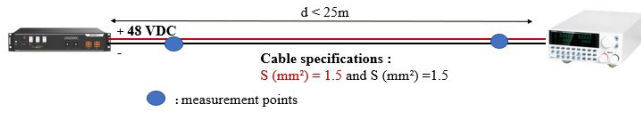

Fig. 5 : Test 2 DC distribution - block diagram

The second test corresponds to the final DC nanogrid part deployment that will be carried out for the DC loads. As this 48VDC (DC) architecture has no converters, voltage drops are taken into account to measure the efficiency of the system.

### C. Theoretical system efficiency

The following calculations have been made to identify the limits of each distribution bus:

The system efficiency is defined as:

$$\eta_{sys} = \frac{\text{Load demand (W)}}{\text{Total power consumed (W)}} \quad (1)$$

With:

- Load demand (W): final power set on the DC electronic load
- Total power consumed (W):
  - **Test 1**: total load demand, that includes additional loads due to converter efficiency.
  - **Test 2**: total load demand, that includes additional loads due to voltage drop.

The calculation of resistance per unit length and then the voltage drop for DC distribution had been calculated by following the methodology of [12]:

$$r = \rho \cdot \frac{l}{s} \quad (2)$$

With :

- $\rho = 0.01724 \Omega \cdot \text{mm}^2/\text{m}$  : copper resistivity
- $l$  (m): distance multiplied per 2 for direct current
- $s$  (mm<sup>2</sup>): cable section

(3)

Then, the voltage drop:

$$\Delta v\% = \frac{I_a \cdot 100 \cdot r}{V}$$

With:

- $I_a$  (A) : maximal intensity used during tests
- $r$  (Ohm/m) : resistance per unit length (2)
- $V$  (V) : chosen distribution bus

The maximum load identified will be 120 W for the tests ( $S=1.5\text{mm}^2$ ,  $d=25\text{m}$ ) in order to respect the NFC 15-100 standard, which indicates not to exceed 3% in voltage drop for lighting and 5% for the other loads, and to use the minimum cable section authorized which is  $1.5\text{mm}^2$ . Tests conditions are described in Tab 2:

TABLE 2 : Tests conditions LifePO4 48VDC battery discharge

Parameters	Test 1: DC/AC/DC	Test 2: DC
Battery nominal capacity (Ah)	50 Ah	
Cooling setpoint temperature room (°C)	27°C	
Time discharge (h)	2 h	
Distance (m)	25 m	
Initial capacity (Ah)	48 Ah	
Initial State Of Charge (%)	96 %	
Section cable (mm <sup>2</sup> )	1.5 mm <sup>2</sup>	
DC programmable load Power (W)	120 W	
DC/AC Inverter efficiency	0.96	-
AC/DC Converter efficiency	0.93	-
Theoretical drop voltage (%)	< 1%	3%
Theoretical system efficiency	0.83	0.96

## IV. RESULTS

### A. Battery discharge

Battery State of Charge (SoC) and capacity (Ah) were measured at the beginning and at the end of each test for 2-hour discharge. For an identical final charge and discharge duration, the system consumed 6.5 Ah in Test 1-DC/AC/DC and 5 Ah in Test 2-DC:

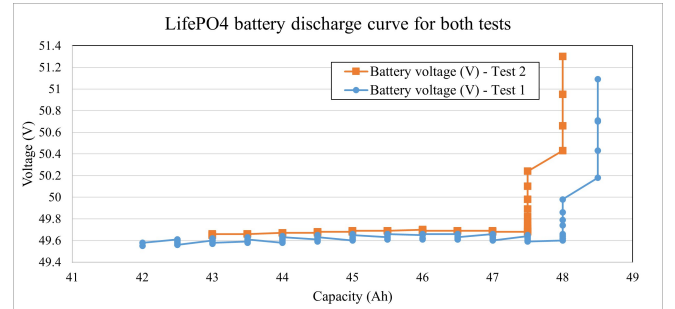

Fig. 6 : LifePO4 battery discharge in DC/AC/DC or DC distribution

### B. System efficiency

The power delivered by the battery and the power required by the programmable load was measured during the 2-hour discharge according to Test 1 and Test 2. As the power consumed in Test 1 - DC/AC/DC is 160W, the efficiency of the system as a whole is 75%. In comparison, the power consumed in Test 2 - DC is 129W so the system efficiency is 93% for Test 2 DC (Fig. 7).

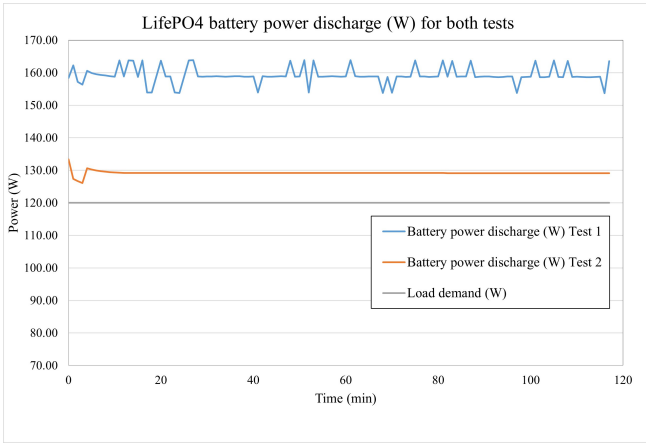

Fig. 7: LifePO4 battery power discharge (W) in Test 1 DC/AC/DC and Test 2 DC

### C. Voltage drop

Since test 1 has an AC/DC converter regulating at a constant output voltage of 48 VDC, the voltage difference is shown only for test 2 DC. A voltage drop between 6.5 and 7% was measured:

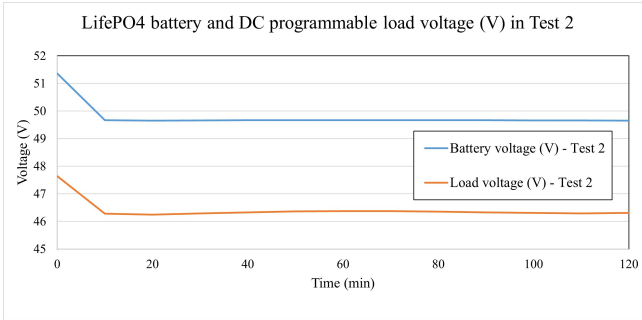

Fig. 8 : Voltage (V) of LifePO4 battery and programmable load in Test 2 – DC distribution.

The summary of the measures is presented in Table 3:

TABLE 3 : Tests measurements LifePO4 48VDC battery discharge

Parameters	Test 1: DC/AC/DC	Test 2: DC/DC
Battery current discharge (A)	3.2A	2.6A
Battery power discharge (W)	159.6 W	129.2 W
Battery final State of Charge (%)	83%	86%
Total power consumed (Wh)	319.2 Wh	258.4 Wh
Average drop voltage (%)	< 1%	7%
Battery current discharge (A)	3.2A	2.6A
System efficiency	0.75	0.93

## V. CONCLUSIONS AND PERSPECTIVES

In the context of a 48VDC nanogrid deployment, 2-hour discharge tests were performed on a LifePO4 battery using two electrical distribution architectures. In both cases, the final load is 120W, the distribution distance is 25m, and the cable section is 1.5mm<sup>2</sup>. These conditions have been defined to respect the current standards limiting the voltage drop to 3%. The first architecture integrates conversion elements such as an inverter and an AC/DC converter. The second architecture does not integrate converters and directly distributes the DC current to the terminal load. For test 1, the

system has an efficiency of 75% and does not involve any voltage drop on the terminal equipment. For test 2, the system has an efficiency of 93% and involves a measured voltage drop of 7%. This discrepancy with the expected voltage drop can be explained by the fact that the temperature impact is not taken into account in the theoretical estimation or by the choice of connectors, or by the reliability of the battery management system (BMS) measurement. It is also could be explained by the impact of battery internal resistance. This margin of error implies that particular attention should be paid to the power supply range, during the choice of the DC terminal equipment, in order to avoid their degradation and impact on their life span. Further experiments will complement these results with a higher cable cross-section (2.5 or 4mm<sup>2</sup>), a higher programmable load, a longer battery discharge and a numerical simulation model of the system in parallel. The instrumentation of the system will also be improved to measure the battery internal resistance. Finally, identical tests will also be done by direct PV auto consumption and with battery charged at its maximum, to evaluate the impact of its internal resistance on system efficiency. These additions should allow us to confirm or not this margin of error measured for the voltage drops and the efficiency of the system as a whole. Finally, the goal of these future experiments is to identify precise conditions and limits of efficiency in terms of wiring, cost and carbon impact for nanogrids office, including PV, LFP batteries and hybrid distribution (AC and DC).

## ACKNOWLEDGMENT

An appreciation is addressed to the company Intégrale Ingénierie, the University of La Réunion, the University of Grenoble Alpes and the ANRT (National Research and Technology Association) for supporting this PhD project's realisation and financing.

## REFERENCES

- [1] French government, "Law n° 2015-992 of August 17, 2015 on the energy transition for green growth", JORF n°0193 of 19<sup>th</sup> august 2015, 2015.
- [2] EDF Réunion, <https://opendata-reunion.edf.fr/>, 2019.
- [3] V. Rakotoson, L. Adelard, J. Praene. "Evaluation of greenhouse gas emissions from the electricity mix of island territories.", IBPSA France conference - Marne-la-Vallée, May 2016, Paris, France. (hal-01486543)
- [4] B. Glasgo, I. Azevedo, C. Hendrickson, "How much electricity can we save by using direct current circuits in homes? Understanding the potential for electricity savings and assessing feasibility of a transition towards DC powered buildings", Applied Energy, vol 180, 2016.
- [5] D. Gerber, R. Liou, R. Brown, "Energy-saving opportunities of direct-DC loads in buildings", Applied Energy, vol 248, 2019.
- [6] D. Burmester, « A review of nanogrid topologies and technologies », Renewable and Sustainable Energy Reviews, 2017.
- [7] J. Ore, "The DC Nanogrid House: Converting a Residential Building from AC to DC Power to Improve Energy Efficiency". Purdue University Graduate School. Thesis. <https://doi.org/10.25394/PGS.14519604.v1>
- [8] S. C. Joseph, S. Ashok and P. R. Dhanesh, "Low voltage direct current (LVDC) nanogrid for home application," 2017 IEEE Region 10 Symposium (TENSYP), Cochin, India, 2017, pp. 1-5, doi: 10.1109/TENCONSpring.2017.8069993.
- [9] H.E. Gelani, F. Dastgeer, M. Nasir, S. Khan, J.M. Guerrero, "AC vs. DC Distribution Efficiency: Are We on the Right Path?", Energies 2021, 14, 4039. <https://doi.org/10.3390/en14134039>
- [10] K. Hafsi, D. Genon-Catalot, J.M. Thiriet, O. Lefevre. "DC building management system with IEEE 802.3bt standard." HSPR 2021 IEEE

International Conference on High Performance Switching and Routing (HSPR), Paris, France, 2021.

- [11] C. Robert, A. Ravey, R. Perey, D. Hissel. "Répartition de l'impact environnemental des batteries LFP suivant différentes étapes du cycle de vie." Conférence des Jeunes Chercheurs en Génie Électrique, Le Croisic, France, 2022. (hal-03783373)
- [12] S. Moussa, M. Jebali-Ben Ghorbal, I. Slama-Belkhodja, "Bus voltage level choice for standalone residential DC nanogrid", Sustainable Cities and Society, vol 46, 2019.
- [13] Jo-Ann V. Magsumbol, M.A. Rosales, M. Gemel B. Palconit, R. S. Concepcion II, A. A. Bandala, R. P. Vicerra, E. Sybingco, A. Culaba, E.P. Dadios, "A Review of Smart Battery Management Systems for LiFePO 4 : Key Issues and Estimation Techniques for Microgrids", Journal of Advanced Computational Intelligence and Intelligent Informatics, 2022. <https://doi.org/10.20965/jaciii.2022.p0824>