



**HAL**  
open science

## Improved circuit model of photovoltaic cell for energy harvesting application

Rahma Hajtaieb Aloulou, Pierre-Olivier Lucas de Peslouan, Jimmy Armand, Hassene Mnif, Frédéric Alicalapa, Mourad Loulou, Jean-Daniel Lan Sun Luk

► **To cite this version:**

Rahma Hajtaieb Aloulou, Pierre-Olivier Lucas de Peslouan, Jimmy Armand, Hassene Mnif, Frédéric Alicalapa, et al.. Improved circuit model of photovoltaic cell for energy harvesting application. 17th IEEE Mediterranean Electrotechnical Conference (MELECON), Apr 2014, Beyrouth, Lebanon. pp.548-552, 10.1109/MELCON.2014.6820594 . hal-01202268

**HAL Id: hal-01202268**

**<https://hal.univ-reunion.fr/hal-01202268v1>**

Submitted on 12 Dec 2024

**HAL** is a multi-disciplinary open access archive for the deposit and dissemination of scientific research documents, whether they are published or not. The documents may come from teaching and research institutions in France or abroad, or from public or private research centers.

L'archive ouverte pluridisciplinaire **HAL**, est destinée au dépôt et à la diffusion de documents scientifiques de niveau recherche, publiés ou non, émanant des établissements d'enseignement et de recherche français ou étrangers, des laboratoires publics ou privés.



Distributed under a Creative Commons Attribution - NonCommercial 4.0 International License

# Improved Circuit Model Of Photovoltaic Cell For Energy Harvesting Application

Rahma Aloulou<sup>(1,2)</sup>, P-O lucas de Peslouan<sup>(2)</sup>, J. Armand<sup>(2)</sup>, Hassene Mnif<sup>(1)</sup>, Frederic Alicalapa<sup>(2)</sup>  
Mourad Loulou<sup>(1)</sup>, J. D. Lan Sun Luk<sup>(2)</sup>

<sup>(1)</sup>University of Sfax- LETI Laboratory. Sfax-Tunisia

<sup>(2)</sup>LE2P Lab-University of La Reunion Saint Denis, Reunion (France)

[aloulourahma@yahoo.fr](mailto:aloulourahma@yahoo.fr), [po.peslouan@gmail.com](mailto:po.peslouan@gmail.com), [jarmand@univ-reunion.fr](mailto:jarmand@univ-reunion.fr), [hassene.mnif@ieee.org](mailto:hassene.mnif@ieee.org),  
[frederic.alicalapa@univ-reunion.fr](mailto:frederic.alicalapa@univ-reunion.fr), [mourad.loulou@ieee.org](mailto:mourad.loulou@ieee.org), [lanson@univ-reunion.fr](mailto:lanson@univ-reunion.fr)

**Abstract**— This paper mainly focuses on model of photovoltaic cell for energy harvesting application (EHV). This model is developed using the standard simulation software LTspice to explore the effect of electrical and physical parameters on Current-Voltage (I-V) and Power-Voltage (P-V) characteristics of photovoltaic cell (PV). The proposed model is based on mathematical equations and is described through an equivalent circuit. The developed model serves to specify the optimal conditions for operating the PV cell and define the maximum power point (MPP). It also allows the prediction of PV cell behavior as a function of temperature and ambient radiation. To demonstrate the validity of the generated model, an experimental test was performed for a PV cell (of type"ASI" from SCHOTT Company). Experimental and technical data display a good agreement with the simulated findings.

**Key words**\_ Photovoltaic cell (PV), energy harvesting (EHV), LTspice, generated model, I-V and P-V characteristics, maximum power point (MPP).

## I. I. INTRODUCTION

In the quest of green energy, getting benefit from renewable energy harvested from environment is becoming an emerging solution to power energy-autonomous devices and improve battery-less circuit by converting environmental energy into usable electrical energy. In this contest photovoltaic cell as efficient converter is increasingly gain importance in wide interesting applications such energy harvesting systems and low power and voltage circuits.

As a result, the main objective of this paper is to realize an improved circuit model of photovoltaic cell using LTspice simulation software. This model is used to define the optimal conditions for operating the PV cell with the maximum power point. Also, this model is able to simulate the behavior of a photovoltaic cell under different environmental conditions, and to present IV and PV characteristics.

This paper is organized as follows. Section 2, represents a brief description of the physical principle to explain the cell operation. In section 3, an effective and flexible model implemented using LTspice is described. This model allows performing an easy manipulation of certain data (irradiance, temperature variable resistances...) these findings are investigated in section 4 and discussed. Section 5 is reserved to demonstrate the validity and the stability of the model; the simulated IV and PV graphs are compared with experimental and technical data of the commercial panel provided by the manufacturer. Finally, conclusions will be given in sections 6.

## II. PHOTOVOLTAIC CELL MODEL

Mainly, a solar cell consists of reverse-biased P-N junction that governs the diode characteristics as well as the photovoltaic effect (Figure1). Each cell can convert incident sunlight into electrical power by the photovoltaic conversion. In fact, when exposed to light, the photons of sunlight are absorbed in the silicon, and then electron-hole pairs are generated [1]. These excess electrical charges flow an external load connected across the cell to provide electricity: a photocurrent (I) proportional to light and independent voltage (V) (Figure1). Nevertheless, in the dark, the I-V characteristic of a PV cell is similar to that of a diode. [2].

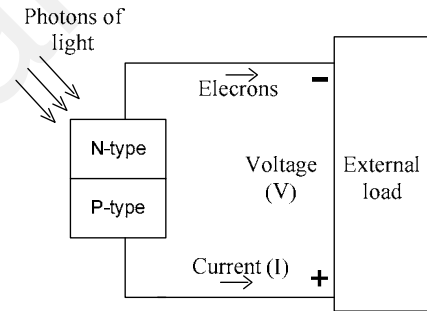

**Figure1. The physical principle of PV cell and the generation of photocurrent**

Hence, a simplified equivalent electric circuit can be deduced to describe the cell operation. This equivalent circuit is based on 4 components: A current source, a diode and two resistors (figure2).

- **A photocurrent source  $I_{ph}$**  which proportional to the illumination.
  - **A diode** models the behavior of the cell in the dark. It is characterized by a reverse saturation current,  $I_0$ .
  - **Two resistors** model the internal losses
- .Serial Resistor  $R_s$ :** reflects losses incurred by non-ideal conductors  
**.Shunt Resistor  $R_p$ :** symbolizes losses incurred by conductors

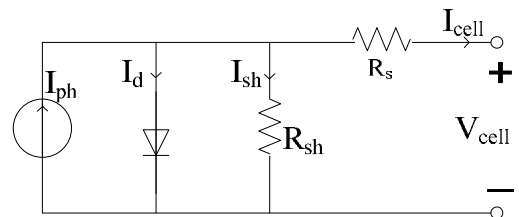

**Figure2. PV cell equivalent circuit**

According to [3, 4] and based on the equivalent circuit (Figure 1), for a single cell the current provided can be calculated as:

$$I_{cell} = I_{ph} - I_d - I_{sh} \quad (1)$$

$$I_{cell} = I_{ph} - I_0 \left[ \exp\left(\frac{V_{cell} + I_{cell}R_s}{U_T}\right) - 1 \right] - \left(\frac{V_{cell} + I_{cell}R_s}{R_{sh}}\right)$$

With  $U_T = \frac{KT}{q}$ :

Where:

**T**: temperature of cell (in Kelvin, K)

**K**: Boltzmann constant ( $k= 1.38e-23$ )

**q**: the electronic charge ( $q = 1.602e-19$  C)

The plot of this generated current against voltage for a typical PV cell is presented in figure 3.

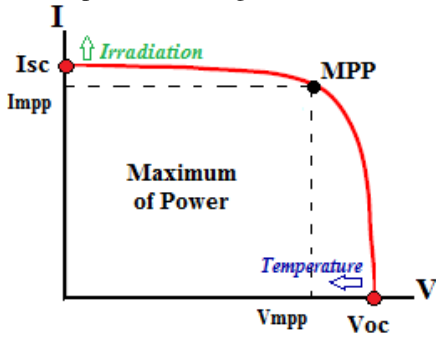

Figure3. Current-Voltage (I-V) characteristic for the PV cell

From Figure 3, some important features of (I - V) Curve can be observed and can be defined as:

- a)  $V_{OC}$ , Open circuit voltage; the voltage drop across the diode junction in the dark ( $I_{ph} = 0$ ).
- b)  $I_{SC}$ , Short-circuit current; the maximum provided current in the short circuit conditions ( $V = 0$ )
- c) **MPP**, Maximum power point; optimal operation condition of the PV cell.

$$d) \eta, \text{ The efficiency; } \eta = \frac{P_{mpp}}{P_{in}} = \frac{I_{mpp} \cdot V_{mpp}}{A \cdot G}$$

Where **A** represents the cell area and **G** ( $W/m^2$ ) is the ambient irradiation. [3].

In general, a PV cell generates low voltages that depend on the semiconductor and the technology choice. Therefore, to improve PV system performances, usually, a number ( $N_s$ ) of cells are deposit in series into a string, and a number ( $N_p$ ) of strings are putted in parallel. The current and the voltage will be expressed as:

$$I = N_p I_{cell} \text{ and } U = N_s U_{cell} \quad (2)$$

### III. GENERALIZED PV CELL MODEL BUILDING AND SIMULATION RESULTS

To achieve an easy manipulation of basic cell parameters and investigate their effect on the electrical characteristics of PV system an efficient modeling of the solar cell is proposed using LTspice simulator. Therefore, this paragraph aims to present the developed model. The realized model can be described through the schematic tool (Figure4) or/and a generated netlist.

About Figure 4, and in order to characterize the basic unit of a photovoltaic cell a spice sub\_circuit is adopted. The sub\_circuit introduced specifies the provided current at a given irradiance as:

$$girrad = \frac{A \cdot J_{sc}}{1000} \cdot G = \frac{I_{sc}}{1000} \cdot G \quad (3)$$

Where the *girrad* source is considered as a Voltage-controlled current source and  $J_{sc}$  is the current density.

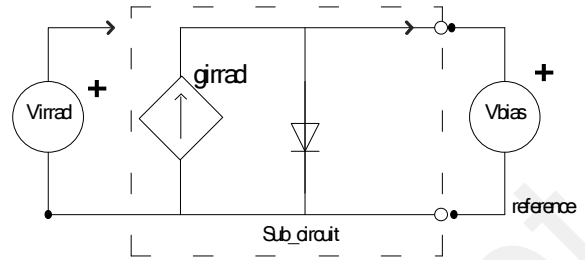

Figure4. The spice sub\_circuit model

In order to apply these concepts and generate an efficient spice-netlist, a given PV cell has been chosen for modeling. In fact, developing a practice cell-model requires a precise knowledge of parameters provided by the manufacturer. (table1).

Table 1 Specifications of the PV system

Company	SCHOTT Company
Cell type	ASi : Amorphous silicon
Size	21 cm <sup>2</sup> (7cm x 3cm)
Standard	STD AM1.5G
Maximum Power <i>MPP</i> [mW]	98
Short circuit Current <i>I<sub>sc</sub></i> [mA]	35
Open Circuit Voltage <i>V<sub>oc</sub></i> [V]	4.9
Current, max power <i>I<sub>mpp</sub></i> [mA]	28
Voltage, max power <i>V<sub>mpp</sub></i> [V]	3.5

The performance of the cell is normally evaluated under the standard test condition (STC), with an average solar spectrum at AM 1.5. The irradiance is normalized to 1000W/m<sup>2</sup>, and the cell temperature is at 25 °C. Accordingly, the generated I-V and P-V curves are reported in figure 5

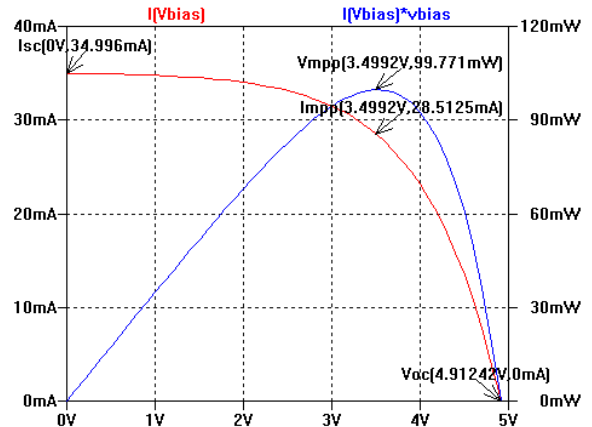
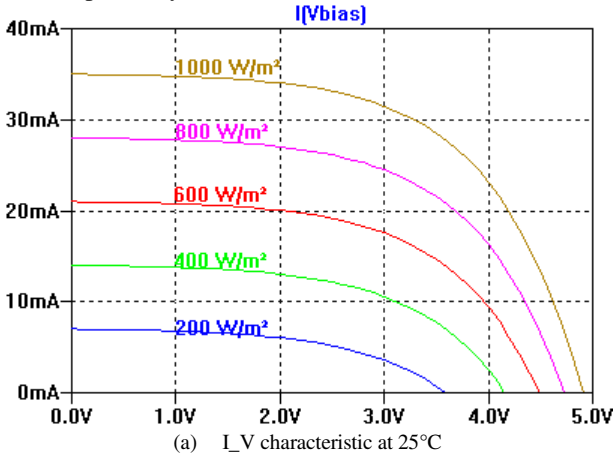

Figure5. Generated I-V and P-V curves

As we can see from figure5, each curve has point of maximum that is the optimum operating point. The cell must work at these points for an efficient use. There are also two other significant points  $V_{OC}$  and  $I_{SC}$ . These key specifications when compared with those provided in the manufacturer's data sheet (table1) display a good concordance and prove the validity of the cell-model.

#### IV. EFFECT OF ENVIRONMENTAL PARAMETERS

In fact, PV cell exhibits a nonlinear I-V and P-V characteristics depending on the cell temperature ( $T$ ), the ambient radiant ( $G$ ) and the resistors ( $R_{sh}$   $R_s$ ). Since, the developed netlist allows the prediction of the PV cell behavior as function of this variation; this section aims to extract the I-V and P-V curves for the given PV cell as a function of solar ambient radiation (figure6), temperature (figure7) shunt resistor and finally series resistance (figure8 and 9) respectively.



(a) I\_V characteristic at 25°C

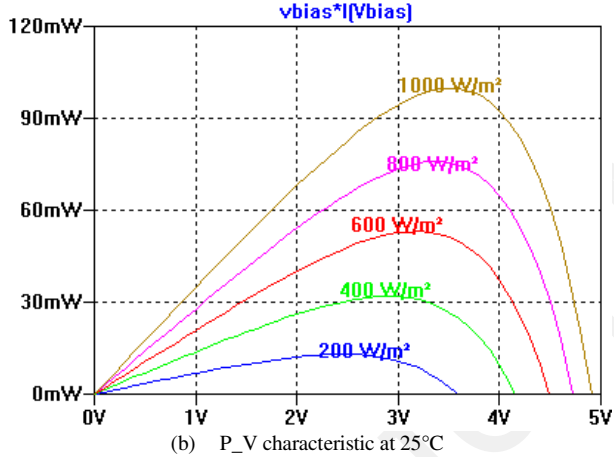

(b) P\_V characteristic at 25°C

Figure6. Effect of varying ambient radiation (at 25°C)

As it can be seen from figure 6, the provided current is strongly dependent on the solar radiation. The short circuit current is a linear function of the ambient irradiation. So, the higher the irradiation the greater the current. However, the  $V_{oc}$  is lightly varied.

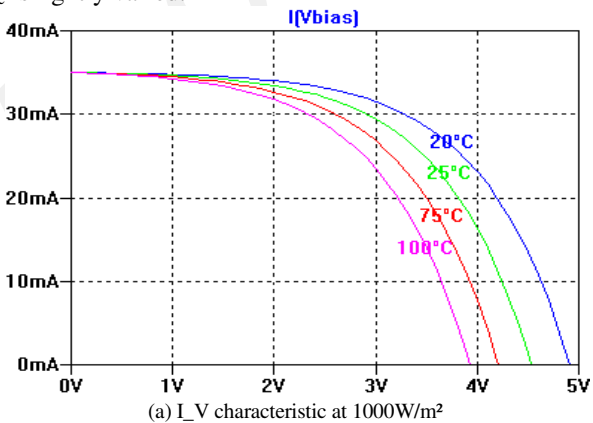

(a) I\_V characteristic at 1000W/m²

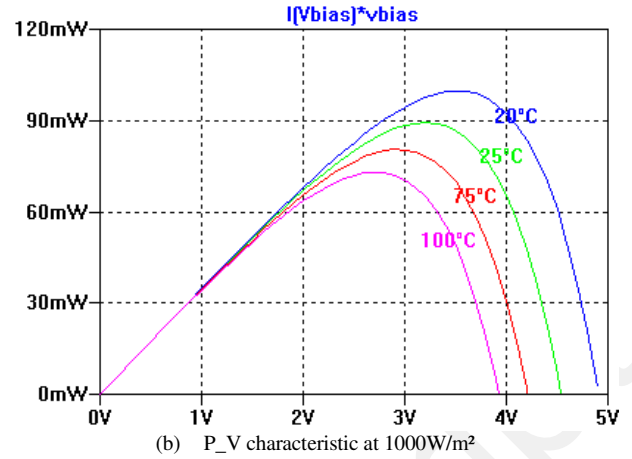

(b) P\_V characteristic at 1000W/m²

Figure7. Effect of varying temperature (at 1000W/m²)

With an ambient irradiance  $G = 1000W/m^2$ , while the cell temperature increasing, we note that the  $V_{oc}$  is dropped whereas the  $I_{sc}$  increased. Consequently, the PV system will be less efficient

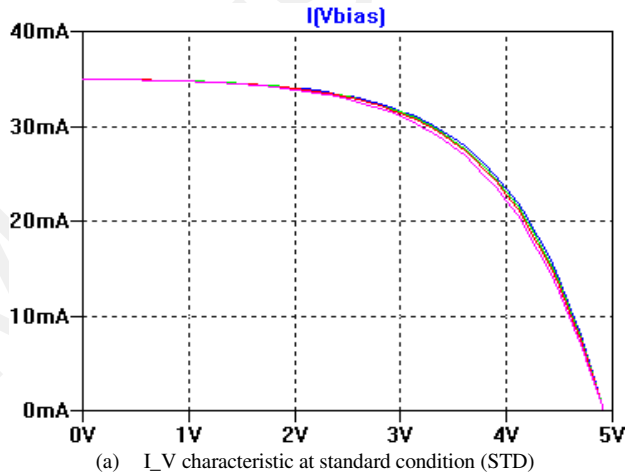

(a) I\_V characteristic at standard condition (STD)

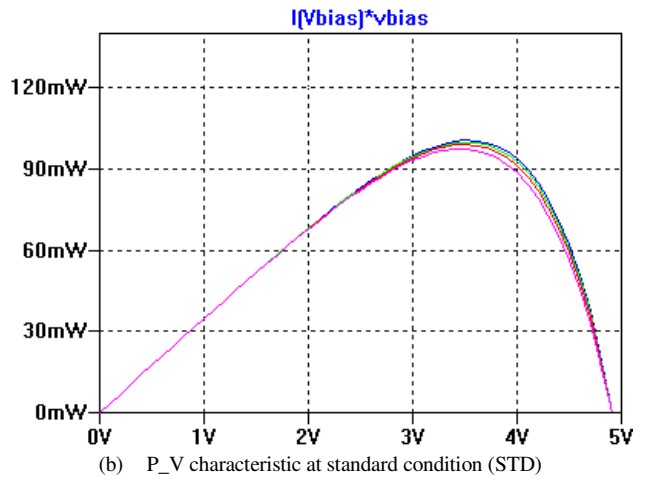

(b) P\_V characteristic at standard condition (STD)

Figure8. Effect of varying  $R_s$  (Serial Resistor)

The serial resistances are always very low and in most of cases are neglected. In this paper, the  $R_s$  is included on the model and enable the proposed netlist to be used for any given PV cell.

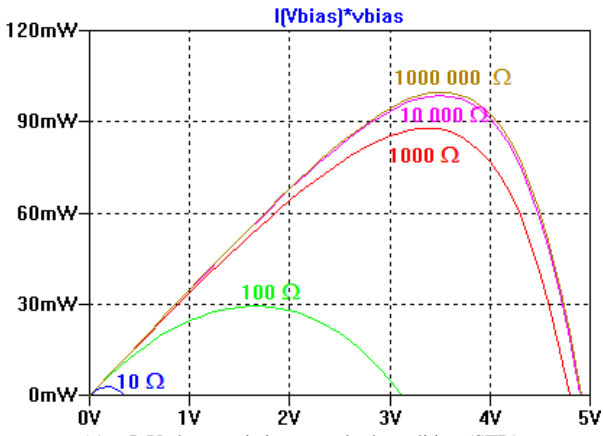

(a) I-V characteristic at standard condition (STD)

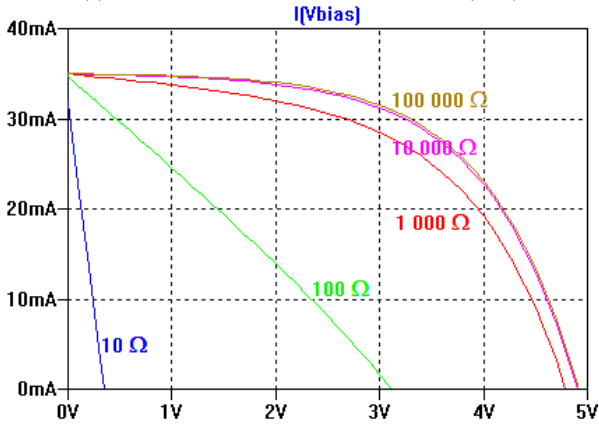

(a) I-V characteristic at standard condition (STD)

Figure9. Effect of varying Rsh (Shunt Resistor)

As described, in figure 9, the variation of the shunt resistance, Rsh affects the slope angle of the I-V characteristics with the attendant deviation from the maximum power point. Consequently, practical PV cell must have high value of Rsh and low value of Rs for providing more output power

## V. EXPERIMENTAL RESULTS AND VALIDATION

This experimental test exhibits the I-V graphs and includes also an investigation related to the delivered power behavior, which is an interesting engineering characteristic in the PV cell. Figure 9 illustrates the experimental test bench where the used materials are as following:

- A PV cell (of type ASI from SCHOTT company)
- A pyranometer (of type CM11)
- lamp Kaiser 1000 to calibrate the pyranometer
- 2 multimeters (or an ammeter and a voltmeter)
- Insulated wires with alligator clips or other cables
- A rheostat

The PV cell characterized in this activity are of type ASI (Amorphous silicon: atoms distributed irregularly in the material) OEM indoor from SCHOTT company. For different values of load resistors, we will determine the characteristic (I-V) for a cell size of 21cm<sup>2</sup> (7cm x 3cm). A pyranometer of type CM11 (figure 11) is used to measure the irradiance on the ground. This irradiance can be expressed by:

$$E_{sol} = \frac{U_{cell}}{S}$$

Where  $E_{Solar}$  (W/m<sup>2</sup>),  $U_{emf}$  (μV) is the output and S is the sensitivity  $\frac{\mu V}{W/m^2}$ . For this pyranometer, the sensitivity was 5.04. Under these conditions, for an irradiance of 1000W/m<sup>2</sup>, we must have  $U_{emf} = 5.04mV$ .

In addition, a temperature sensor was added in contact with the cell to be in standard measurement conditions ambient T = 25 ° C.



Figure10. Experimental PVcell test bench



Figure11. Pyranometer of type CM11

Once the pyranometer illuminated with lamp (Kaiser 1000) was calibrated to receive an irradiance of 1000W / m<sup>2</sup>, the height of the lamp is set to keep the incident light constant for all measurements. After that the pyranometer was replaced with the PV cell which is connected to the rheostat. This experiment examines the effects of demanding energy from the photovoltaic cells for different loads values. Then, the following graphs are obtained.

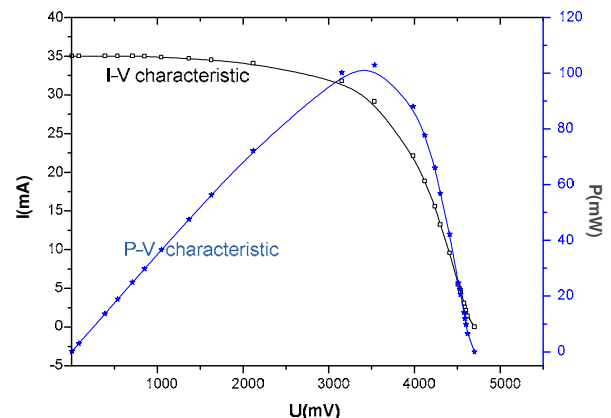

Figure12. Experimental (I-V) and (P-V) characteristics of the PV cell

Under the same standard conditions of light and temperature, we remark from figure 12 that the experimental test give a satisfaction with the specification recommended by the manufacturer summarized in table 1 and the simulated results ( $V_{oc}$ ,  $I_{sc}$ ,  $I_{mpp}$ ,  $V_{mpp}$ ) of figure 5.

## VI. Conclusion

Photovoltaic cell gets benefit from clean and renewable energy. These cells provide a long service life and high reliability to energy harvesting system and battery less devices. Thus, in this paper researches have been oriented to develop an efficient model using the standard simulation software LTspice. The use of this simple model able to analyze the behavior of the solar cell and to predict the PV cell characteristics as a function of different operating conditions (temperature, light intensity, variable resistors...). Simulation results achieve an IV and PV characteristics which are similar and in accordance with the curves given in the manufacturer's data sheet of the solar panel.

## VII. REFERENCE

- [1] Awodugba and all « Photovoltaic solar cell simulation of shockley diode parameters in matlab », International Journal of Physical Sciences ,vol. 8(22), issue 10, pp 1193-1200, June 2013
- [2] Tarak Salmi and all « MATLAB/Simulink Based Modelling of Solar Photovoltaic Cell », International journal of renewable energy research ,vol.2, No.2, 2012
- [3] J.A. Ramos-Hernanz and all « Two photovoltaic cell simulation models in matlab/simulink », International Journal on “Technical and Physical Problems of Engineering” (IJTPE), vol. 4, issue 10, pp 45-51, March 2012
- [4] S. Nemaand al « Matlab/Simulink Based Study of Photovoltaic Cells/Modules/Array and their Experimental Verification», International Journal of Energy and Environment, Vol. 1, Issue 3, pp. 487-500, 2010.